

SONY[®]

4-206-297-12



420629712

Trinitron Digital TV

Operating Instructions

GB

KD-28DX40U
KD-32DX40U

NOTICE FOR CUSTOMERS IN THE UNITED KINGDOM

A moulded plug complying with BS1363 is fitted to this equipment for your safety and convenience. Should the fuse in the plug supplied need to be replaced, a 5 AMP fuse approved by ASTA or BSI to BS 1362 (i.e. marked with \diamond or \heartsuit) must be used. When an alternative type of plug is used it should be fitted with a 5 AMP FUSE, otherwise the circuit should be protected by a 5 AMP FUSE at the distribution board. If the plug supplied with this equipment has a detachable fuse cover, be sure to attach the fuse cover after you change the fuse. Never use the plug without the fuse cover. If you should lose the fuse cover, please contact your nearest Sony service centre.

How to replace the Fuse

Open the fuse compartment with a flat blade screwdriver, and replace the fuse.

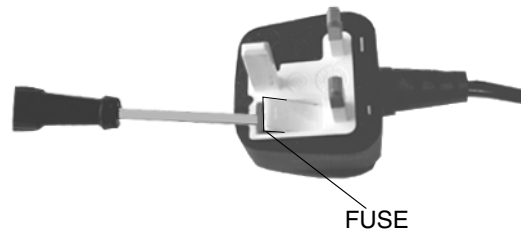

IMPORTANT

If the plug supplied is not suitable for the socket outlet in your home, it should be cut off and an appropriate plug fitted in accordance with the following instructions:

The wires in this mains lead are coloured in accordance with the following code:

Blue:	Neutral
Brown:	Live

As the colours of the wires in the mains lead of this apparatus may not correspond with the coloured markings identifying the terminals in your plug, proceed as follows:

The wire which is coloured blue must be connected to the terminal which is marked with the letter N or coloured black. The wire which is coloured brown must be connected to the terminal which is marked with the letter L or coloured red. Do not connect either wire to the earth terminal in the plug which is marked by the letter E or by the safety earth symbol \perp or coloured green or green and yellow.

WARNING

- To prevent shock hazard, do not insert the plug cut off from the mains lead into a socket outlet. This plug cannot be used and should be destroyed.
- To prevent fire or shock hazard, do not expose the unit to rain or moisture.
- Dangerously high voltages are present inside the set. Do not open the cabinet. Refer servicing to qualified personnel only.

How to move your TV and stand safely



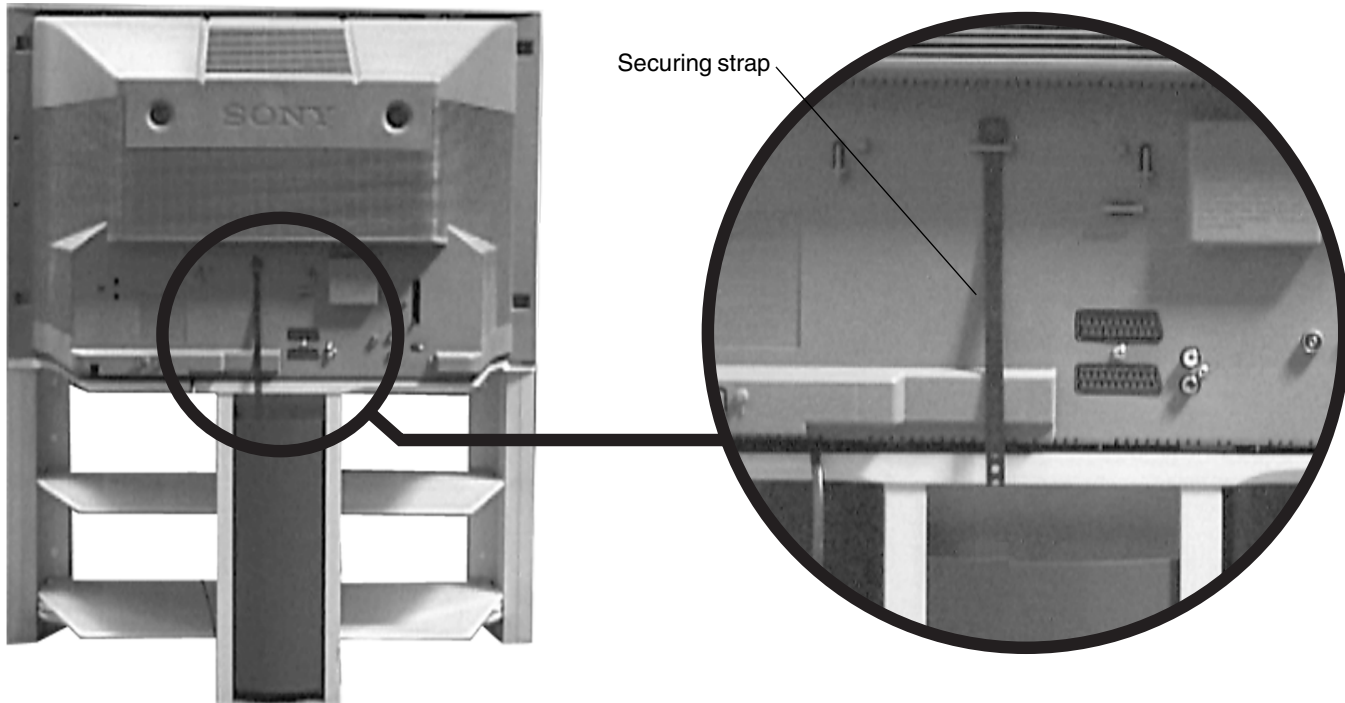

The following instructions **MUST** be observed when moving the TV and stand.

NEVER attempt to move the TV and stand together.

1. Disconnect the securing strap completely (please refer to the instructions supplied with the stand). **NEVER** attempt to move the TV or stand with the securing strap in place.
2. Move the TV to a strong, flat surface. Take care not to trap your fingers.
3. Move the stand to it's new location.
4. Return the TV to the stand.
5. Replace the securing strap.

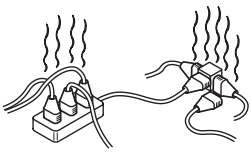
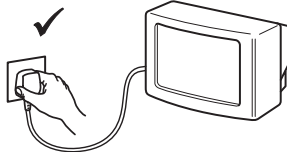
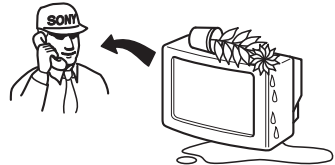
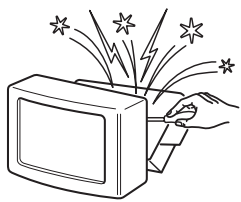
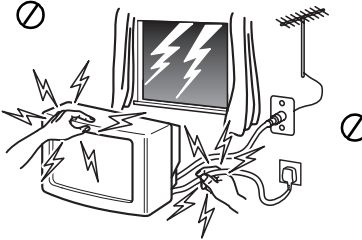
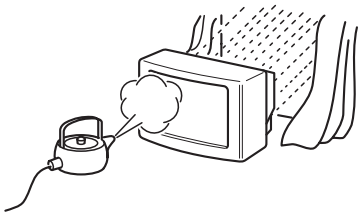
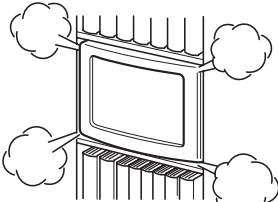
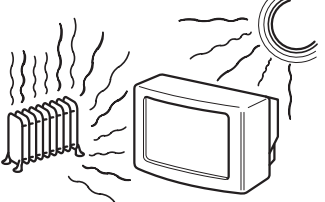
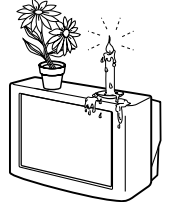

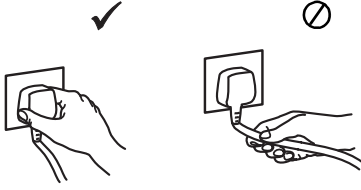
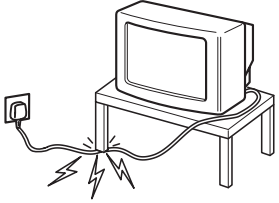
Safety Information

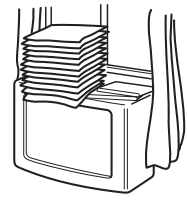
 <p>This set is to operate on a 220-240V AC supply only. Take care not to connect too many appliances to the same power socket as this could result in fire or electric shock.</p>	 <p>For environmental and safety reasons, it is recommended that the TV set is not left in standby mode when not in use. Disconnect from the mains.</p>	 <p>Never push objects of any kind into the set as this could result in a fire or electric shock. Never spill liquid of any kind on the set. If any liquid or solid object does fall through, do not operate the TV. Have it checked immediately by qualified personnel.</p>
 <p>Do not open the cabinet and the rear cover of the TV. Refer to qualified service personnel only.</p>	 <p>For your own safety, do not touch any part of the TV, power lead or aerial lead during lightning storms.</p>	 <p>To prevent fire or shock hazard, do not expose the TV to rain or moisture.</p>
 <p>Do not cover the ventilation openings of the TV. For ventilation, leave a space of at least 10cm all around the set.</p>	 <p>Never place the TV in hot, humid or excessively dusty places. Do not install the TV where it may be exposed to mechanical vibrations.</p>	 <p>Do not place any objects on the TV. To prevent fire, keep inflammable objects or naked lights (e.g. candles) away from the TV.</p>
 <p>Clean the TV with a soft, lightly dampened cloth. Do not use benzine, thinner or any other chemicals to clean the TV. Do not scratch the TV screen. As a safety precaution, unplug the TV before cleaning it.</p>	 <p>Pull out the power lead by the plug. Do not pull on the power lead itself.</p>	 <p>Take care not to place heavy objects on the power lead as this could result in damage. We recommend you wind any excess lead around the holders provided on the rear of the TV.</p>
 <p>Do not allow children to climb on the TV. Place the TV on a secure stable stand. Do not place the TV on its side or face up.</p>	 <p>Unplug the power lead before moving the TV. Avoid uneven surfaces, quick steps or excessive force. If the set has been dropped or damaged, have it checked immediately by qualified service personnel.</p>	 <p>Do not cover the ventilation openings of the TV with items such as curtains or newspapers etc.</p>

2 Safety Information

Thank you for choosing this Sony Trinitron Digital Television.

Before operating this TV, please read this instruction manual thoroughly and retain it for future reference.

Throughout this instruction manual you will notice illustrations of the remote control with certain buttons shaded white.

This shading indicates the buttons you will need to press when following the instructions.

For example, the illustration on the right shows that the MENU, \uparrow , \downarrow , \rightarrow and OK buttons will need to be pressed.

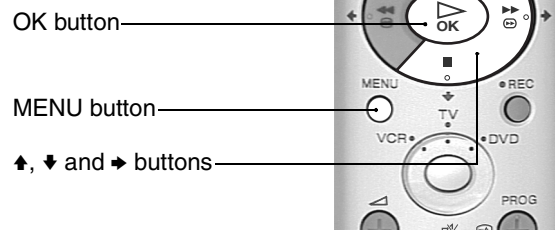

Table of contents

Getting Started

Checking the accessories supplied	4
Inserting batteries into the remote control	4
Connecting an aerial and a VCR	5
Switching on the TV	5
Automatically tuning the TV	6
Watching a pre-recorded video tape	6

Basic Operation

Overview of the remote control	7
Overview of the TV buttons	8
Selecting Digital or analogue mode	9
The Programme Index table	9
The Channel Index menu	9
Watching Widescreen programmes	11
Viewing Digital Teletext	12
Teletext (Analogue)	13
The Digital EPG menu	14
The Digital INFO display	16

Advanced Operation

The Main Menu	17
The TV menu system	22
The Picture Adjustment menu	22
The Sound Adjustment menu	22
The Timer menu	23
The Set Up menu	24

Additional Information

Connecting additional equipment	30
Remote control of connected equipment	32
Specifications	33
Troubleshooting	34
Index	35

Getting Started

Follow steps 1 - 6 to install the TV and view TV programmes.

1. Checking the accessories supplied



Remote control



RF Loopthrough cable



Batteries

2. Inserting batteries into the remote control

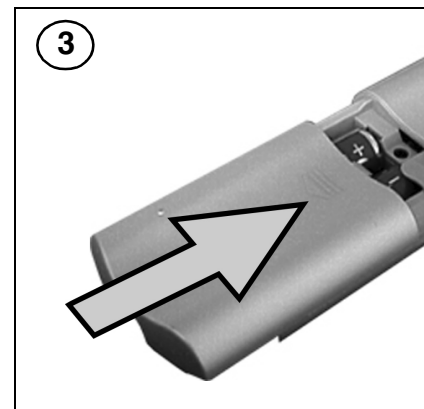
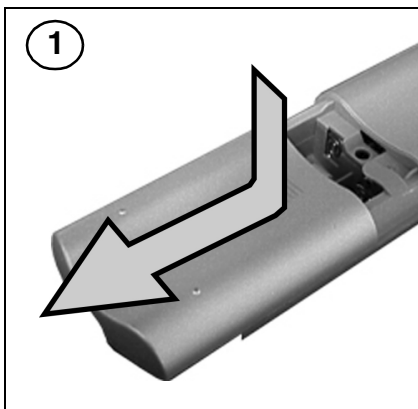

Always remember to:

- observe the correct polarity when inserting batteries,
- dispose of batteries in an environmentally friendly way.

3. Connecting an aerial and a VCR

Connecting an aerial only

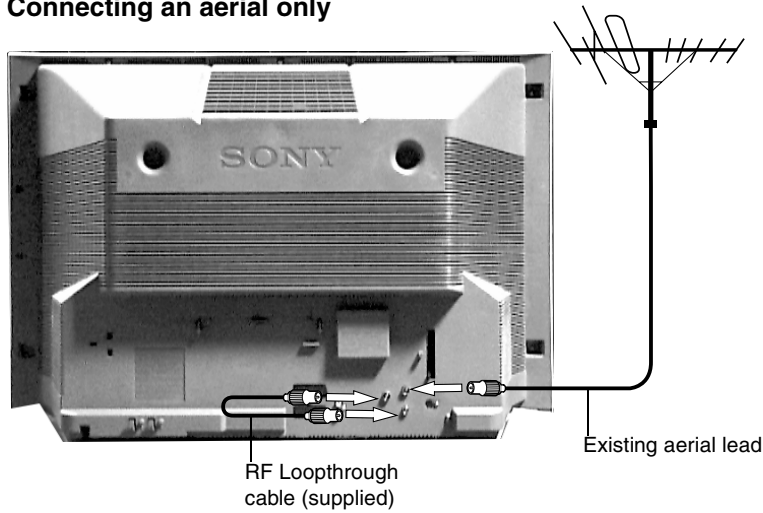

- 1 Connect your existing aerial lead to the upper socket marked RF1 on the rear of the TV as shown.
- 2 Connect the supplied RF loopthrough cable to the sockets marked RF2 and RF3 as shown.

Connecting an aerial and a VCR

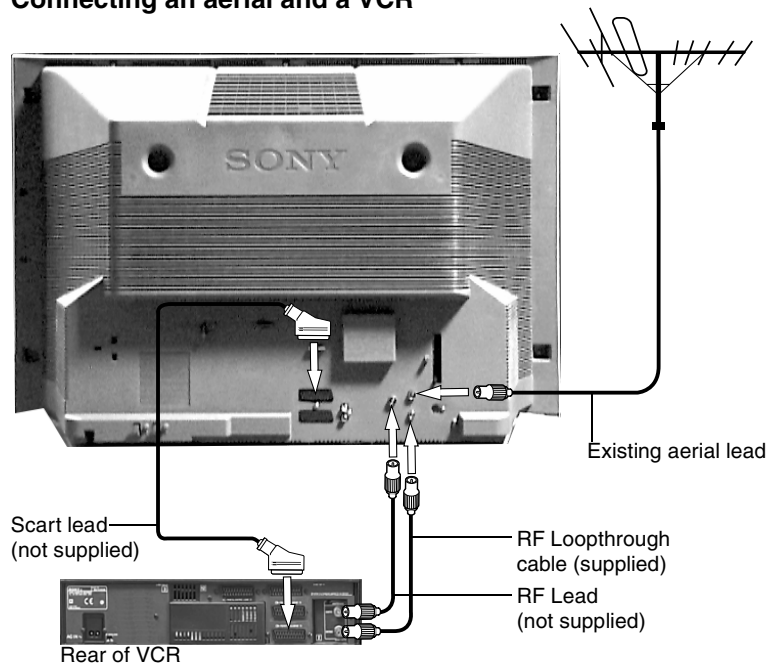

- 1 Connect your existing aerial lead to the upper socket marked RF1 on the rear of the TV as shown.
- 2 Connect the supplied RF loopthrough cable from the aerial socket marked RF2 on the TV to the RF input socket of your VCR.
- 3 Connect an RF lead from the RF output of your VCR to the TV socket marked RF2.
- 4 Connect a scart lead from the scart socket marked SCART on the rear of the TV to a scart socket on your VCR (Refer to the VCR instructions).
- 5 Connect the VCR to the mains socket and switch on.
- 6 Insert a pre-recorded tape into the VCR and press the 'PLAY' button. This enables the TV set to locate and store the video channel during the 'Automatically tuning the TV' procedure.

4. Switching on the TV



- 1 Connect the TV plug to your mains socket (220 - 240V AC, 50 Hz) and switch on.
- 2 Push in the On/Off button (Ⓜ) on the front of the TV.

If the red standby mode indicator on the front of the TV is lit, press the TV I/O button on the remote control to switch on the TV set. Please be patient as the picture may take a few moments to appear on the TV screen.

Getting Started

5. Automatically tuning the TV



1. When you switch on the TV for the first time a menu appears on the screen asking you to check if the picture is slanted. (Sometimes the Earth's natural magnetism can cause the screen to look tilted.)

a) If no correction is required, press the \uparrow or \downarrow buttons on the remote control to highlight 'Not necessary' and press the OK button.

b) If some correction is required, press the \uparrow or \downarrow buttons on the remote control to highlight 'Adjust now', then press the OK button. Correct the slant by pressing the \uparrow or \downarrow buttons then press the OK button to store.

2. The autotune prompt screen appears. Press the OK button to select 'Yes'. The autotune procedure begins.

The Digital autotune display appears on screen and the search and store procedure begins. All the available Digital channels will now be captured and stored. As this may take some time, a message is included in the display to inform you of the tuning progress.

When Digital tuning is complete, the analogue display appears automatically and the search and store procedure for the analogue channels begins.

If no Digital and no analogue channels are found, a menu appears asking you to confirm your aerial is connected. After checking the aerial has been connected press OK to begin the autotune procedure again.

Once all Digital and analogue channels have been captured and stored, the TV returns to normal operation and displays the Digital channel captured on channel number 1.

Note: If no Digital channels are captured, the analogue channel that is stored on channel number 1 is displayed.

3. To view programmes, press the PROG +/- buttons or the numbered buttons.

Checking the picture tilt.



The autotune prompt screen.



Tuning the Digital channels.



Tuning the analogue channels.

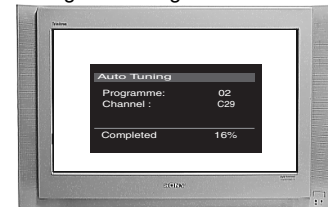

6. Watching a pre-recorded video tape



1. You should have inserted a pre-recorded video tape during the 'Connecting an aerial and a VCR' section. To view the video picture press 'PLAY' on the VCR. The TV automatically displays the video picture (providing that you have used a fully wired 21 pin scart lead to connect your VCR to the TV).

If the video picture does not automatically appear, press the \rightarrow button on the remote control repeatedly until the video picture is displayed on the TV screen.

2. Press the DIGITAL/ button on the remote control to return to normal TV mode.

Note: Alternatively, with the TV in analogue mode, press the PROG +/- buttons on the remote control until the picture from the pre-recorded video tape appears on the TV screen.

If you wish to move your video channel to a different channel number, refer to the 'Programme Sorting' feature in 'The Set Up menu' section of this instruction manual.

Overview of the remote control

VIDEO I/⏻ button

Press to switch off your VCR or DVD temporarily.

DIGITAL/□ button

Press to switch between Digital or analogue mode, or to return to normal TV operation from Teletext.

Screen format button

Press repeatedly to change the screen format.

0 - 9 buttons

When Media Selector is set to TV, press to input the required channel number. For double digit numbers, e.g. for programme 14, press 1 followed by 4.

Information /Reveal button

In TV Mode: In Digital mode, press to display the INFO screen. In analogue mode, press to reveal on screen information such as channel number etc.

In Teletext Mode: Press to reveal concealed information (e.g. answers to a quiz). Press again to cancel.

Coloured buttons

These buttons are used for teletext and for Digital menus. Please refer to the relevant sections in this manual.

EPG button

In Digital mode, press this button to display the Electronic Programme Guide.

Control pad

When in the TV menu system, use these buttons to navigate through the options in each display.

Note: You can only enter the TV menu system if the Media Select button is set to TV. When set to VCR or DVD the control pad buttons operate the main functions of your VCR or DVD.

MENU button

Press to enter the menu system of this TV.

Volume + and - buttons

Press to increase (+) or decrease (-) the volume.



TV I/⏻ button

Press to switch off your TV temporarily. The red standby mode indicator on the front of the TV is lit. Press again to return to normal operation.

Video Input /Hold button

In TV Mode: Press to select signals from equipment connected to the TV sockets (refer to 'Connecting additional equipment').

In Teletext Mode: Press to hold the current page. Press again to cancel.

Previous channel button

Press to return to the previous channel you were watching (provided you watched it for at least 5 seconds).

Note: If the Media Select button is set to VCR, you can use this button to select double digit programme numbers on your VCR, e.g. press the  button then press 2 and 3 for 23.

Analogue Teletext button

In analogue mode, press to switch analogue Teletext on or off.

REC button

When Media Select switch is set to VCR, press this button to begin recording.

Media Select button VCR/TV/DVD

This remote control can operate not only Sony DVDs and VCRs, but also those made by other manufacturers. Press this button to select which type of equipment you want to use. A green light is lit momentarily to show which one you have selected.

Note: Before operating your VCR or DVD you will need to enter the correct configuration code. Please refer to the 'Remote control configuration' section of this instruction manual.

PROG + and - buttons

In TV Mode: Press to display the next or previous channel.

In Teletext Mode: Press to select the next or previous Teletext page.

Mute button

Press to mute the TV sound. Press again to restore the sound.

Basic Operation

Overview of the TV buttons



Press the door flap as shown.



The control panel appears.

Video input button

Press to select signals from equipment connected to the TV sockets (refer to 'Connecting additional equipment').

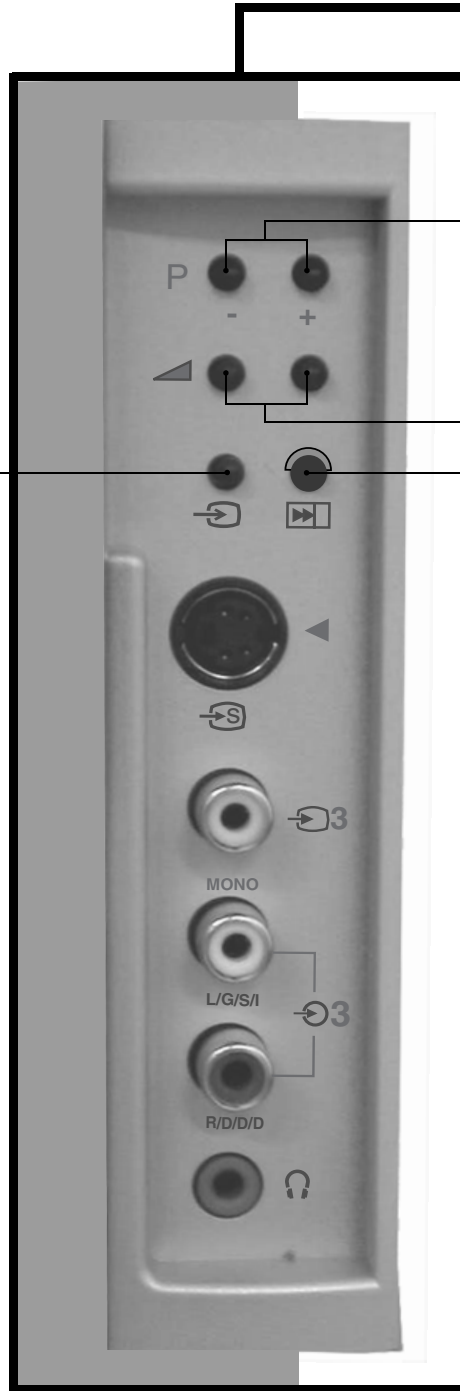

Programme Up or Down buttons

Press to display the next or previous channel.

Volume control buttons

Press to increase (+) or decrease (-) the volume.

Auto tune button

Press to start the automatic tuning process.
Note: Take care - this will totally retune the TV.

Selecting Digital or analogue mode

Press the DIGITAL/□ button on the remote control to switch between Digital and analogue mode. To check if you are watching a Digital or analogue mode press the PROG +/- button. If you are watching a digital programme a banner will appear momentarily at the top of the screen.

The Programme Index table

The 'Programme Index table' is a quick and easy way to search for a channel you wish to view. The 'Programme Index table' is only available in analogue mode.

1. Press the OK button to display the 'Programme Index table' on screen.

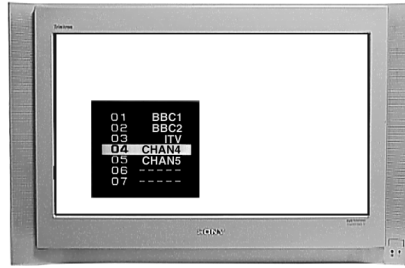
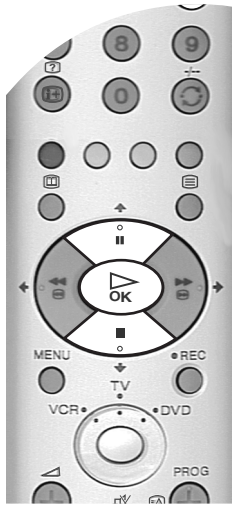

2. Press the ↓ or ↑ button to scroll through the list until the channel you wish to view is highlighted.
3. Press the OK button to display your chosen channel on the TV screen.

The Channel Index menu

The 'Channel Index menu' provides you with a quick and easy way to:-

- a) View a complete list of the programmes available for selection,
- b) Obtain a preview of the programmes contained in the list,
- c) Search for a programme quickly by selecting from different categories of programmes,
- d) Store programmes into a list of favourites.

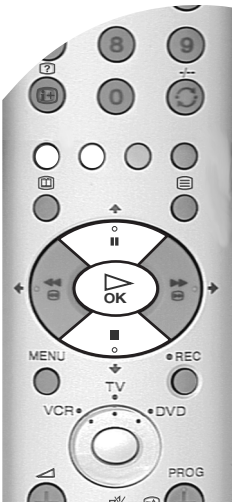

The 'Channel Index menu' is only available in Digital mode.

1. Press the OK button on the remote control to display the 'Channel Index menu' on the TV screen. The menu contains a list of all the available channels. The name of the programme currently being shown along with its start and finish times is shown for each of the available channels. The current channel is previewed in the top right corner of the screen with its channel name and number displayed below it.
2. Press the ↑ or ↓ buttons to move the coloured cursor up or down the list to select the desired programme. If you do not want to select a programme from the 6 channels listed, press the GREEN button to display the next 6 programmes or the RED button to display the preceding 6 channels.
3. Press the OK button to display the highlighted programme in the preview window*.
4. Press the OK button to exit the 'Channel Index menu'. The programme that was being previewed will be displayed.

***Note:** If an age limit for viewing has been set and the programme selected exceeds that age limit, you will need to enter your PIN code before the preview is displayed. Refer to 'The Main Menu' for more information on the 'PIN Code' feature. Programmes that exceed the age limit you have set will be identified by a  symbol.

Basic Operation

The Category pop-up list

The 'Category' pop-up list allows you to quickly search for a programme by choosing from different categories of programmes.

1. With the 'Channel Index menu' on screen, press the YELLOW button to display the 'Category' pop-up list.



2. Press the \uparrow or \downarrow buttons to highlight the required category. The category you choose will be displayed in a title bar at the top of the programme list along with the date and time.
3. Press the OK button. The 'Channel Index menu' will now contain only programmes of the type selected.

The following categories are available:

Favourite Choice	Contains all the programmes you have stored as a favourite (see below).
Recent Prog.	The TV will create this list based on the type of programmes you watch the most.
All Categories	Contains the last 5 programmes watched.
Sports	Contains all available channels.
News	Contains all sport channels.
Film	Contains all news channels.
Entertainment	Contains all film channels.
Lifestyle	Contains all entertainment channels.
Education	Contains all lifestyle channels.
Kids	Contains all education channels.
	Contains all kids channels.

Favourite programmes

This feature allows you to create a list of your favourite programmes.

To add a programme to the Favourite list

1. With the 'Channel Index menu' on screen, press the \uparrow or \downarrow buttons to highlight the programme you want as a favourite.
2. Press the BLUE button to store the programme in the favourite list.

To remove a programme from the Favourite list

1. With the 'Channel Index menu' on screen, press the YELLOW button to access the 'Category' pop-up list.
2. Highlight the 'Favourite' category. Press the OK button to display the 'Favourite list'.
3. Highlight the programme you wish to remove from the 'Favourite list'.
4. Press the BLUE button to remove the programme.





Watching Widescreen programmes

The pictures that the TV receives may be transmitted by the broadcaster in more than one format (e.g. conventional 4:3 format, 16:9 widescreen format). You can alter the TV screen format manually to suit the broadcast you are watching. Press the  button on the remote control repeatedly until the format you require appears. You can choose from 5 different formats as shown below:

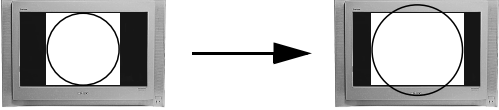
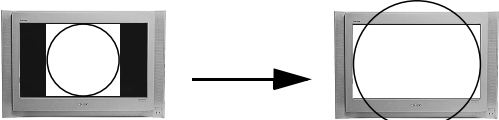
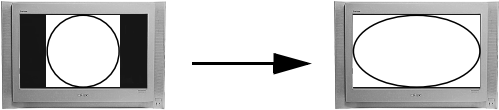
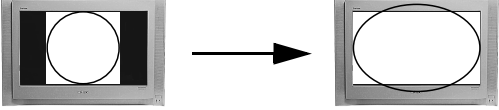







- 4:3** 
Conventional screen format.
- 14:9** 
Compromise between the 4:3 and 16:9 formats.
- Zoom** 
Imitation of wide screen effect for movies shown in cinemascopic (letter box) format.
- Wide** 
For 16:9 broadcasts.
- Smart** 
Imitation of wide screen effect for 4:3 broadcasts.



Note: In 'Smart', 'Zoom' and '14:9' formats, parts of the bottom and top of the picture will be cut off. Press the  or  buttons to adjust the position of the picture on the screen (e.g. to read subtitles).

Using Auto Format

This TV can automatically detect the type of screen format being transmitted by the broadcaster*. With 'Auto Format' set to 'On', the TV switches to the correct screen format automatically.

1. Press the MENU button to display the main menu. Use the  or  button to highlight the  symbol. Press the  button to enter the 'Set Up' menu.
2. 'Auto Tuning' is highlighted. Press the  or  buttons to highlight 'Detail Set Up' then press the  button to display the 'Detail Set Up' menu on screen.



3. 'Auto Format' is highlighted. Press the  button to select, then use the  or  button to set to On**.
4. Press the OK button to store. Press the MENU button to return to normal TV operation.

Notes: *Only if the specific signals are transmitted with the programmes.
**When 'Auto Format' is set to 'Off', the screen maintains the format you selected from the 5 available options (see above).







Basic Operation

Viewing Digital Teletext



Many broadcasters now provide a Digital Teletext service in the form of a dedicated Teletext channel. This Digital service includes high quality text and graphics along with advanced navigation options.

The appearance, content and navigation methods of all Digital Text services are decided by the broadcaster. For example, Digital Text from the BBC may look different to Digital Text from ITV which may use different navigation methods. Most of the Digital Text services currently available use simple navigation methods based on the following buttons:

- The  button (Text button) to load Digital Teletext.
- The , ,  and  buttons (to move around the screen),
- The OK button (to select items on screen),
- The  button (to cancel a selection or exit Digital Teletext),
- The four coloured buttons (to access shortcuts).



Dedicated Digital Teletext channels

1. If the TV is not already in Digital mode, press the DIGITAL/ button on the remote control. Press the numbered buttons on the remote control to select a dedicated Teletext channel number. To find out the channel number of a dedicated Digital Teletext channel, use the 'Channel Index menu'. (Please refer to 'The Channel Index menu' section of this instruction manual.)













2. Once the Teletext channel is displayed, follow the on-screen instructions to access the required information.

Note: On some pages the TV programme is also displayed. Instructions on-screen will tell you how to change the displayed programme.

3. If when viewing the Teletext pages, you are requested to select 'OK' or 'Cancel', press the OK button for 'OK' and the  button for 'Cancel'.
4. When you have finished viewing Teletext, press the  button to exit.

Selecting Teletext from other Digital channels

Normal Teletext services may also be available on other Digital channels. Sometimes this is indicated by a small symbol or text display on your TV screen, superimposed on the channel you are watching.

1. Press the , ,  or  buttons to select the symbol then press the OK button to display the chosen information.
2. Alternatively, you may be requested to use the numbered and coloured buttons on your remote control to display the various pages of text information. If when viewing the teletext pages, you are requested to select 'OK' or 'Cancel', press the OK button for 'OK' and the  button for 'Cancel'.
3. Once the text information is displayed on screen, use the , ,  or  buttons, the coloured buttons and/or the numbered buttons to access the chosen information.
4. When you have finished viewing Teletext, press the  button and then select an alternative Digital channel.



Teletext (Analogue)

Most analogue TV channels broadcast a Teletext service. The index page (usually page 100) provides information on how to use the service. Please ensure you are receiving a good signal, or some Teletext errors may occur.

Switching Teletext on and off

1. If the TV is not already in analogue mode, press the DIGITAL/□ button on the remote control. Select the analogue TV channel which carries the Teletext service you want to view.
2. Press the [Teletext] button to enter Teletext mode, then using the numbered buttons on the remote control, enter the three digits of the page number you wish to view. Alternatively, press the [EΔ] or [E▽] buttons to view the previous or next page. After a short time it will appear on screen.



3. Enter more 3 digit page numbers as required.
4. Press the DIGITAL/□ button to exit Teletext.

How to use Teletext features

	Feature	How to use
Hold	Some pages contain sub-pages which follow on automatically. This feature allows you hold the current page until you are ready to proceed.	Press the [Hold] button to hold the page currently being displayed. Press again to cancel.
Reveal	Some Teletext pages contain hidden information (e.g. for a quiz).	Press the [Reveal] button to reveal the hidden information. Press again to cancel.
Mix	This feature allows you to superimpose Teletext on to the TV screen.	In Teletext mode, press the [Mix] button to superimpose Teletext on to the TV screen. Press the [Mix] button again to exit Teletext.
Fastext	Fastext allows you to access pages quickly and easily. When Fastext is available, four coloured items appear at the bottom of the screen.	Press the corresponding coloured button on the remote control to access the required page.



Basic Operation

The Digital EPG menu

The EPG menu (Electronic Programme Guide) provides you with a quick and easy way to:-

- View a complete list of the programmes available.
- Obtain a preview of the programmes currently being broadcast.
- Reduce the size of the list by selecting a category of programme, e.g. Sports or Movies.
- Record programmes.



- The EPG menu is only available when watching Digital channels. If the TV is not already in Digital mode, press the DIGITAL/□ button on the remote control. Press the □ button on the remote control to display the EPG menu screen. This screen consists of an information window, a preview window, a 2 hour timer bar (divided into 30 minute intervals) and a 5 channel programme list covering the 2 hour period.



- Press the ▲ or ▼ buttons to move the coloured cursor bar up or down the programme list and the ► or ◀ buttons to move left and right. If you press the ► button once more after highlighting the last programme on the right, the programmes scheduled for the next 2 hour period are displayed. As each programme is highlighted, a brief description of the programme appears in the event information box at the top left of the screen. If you do not wish to select a programme from the 5 channels listed, press the GREEN button to display the next 5 channels or RED button to display the previous 5 channels.
- If a programme you highlight is currently being broadcast, press the OK button to obtain a preview in the preview window. If you have previously set a viewing age limit in the 'Digital Setting' menu, and the programme exceeds that age limit, you will be asked to enter your PIN code before the preview is allowed.
- When the programme in the preview screen is the one you wish to watch, press the OK button to exit the EPG menu and view the programme at full size.

The Category pop-up list

The 'Category' pop-up list allows you to quickly search for a programme by choosing from different categories of programmes. For example, select the 'News' option from the 'Category' pop-up list to display programme information only for News channels.



- With the EPG menu on screen, press the YELLOW button to display the 'Category' pop-up list.
- Press the ▲ or ▼ buttons to highlight the category you want, then press the OK button. The EPG programme list will now only contain programmes of the type selected.



For information on the types of Categories along with instructions on how to add and remove programmes from the Favourite list, please refer to 'The Channel Index menu' section of this instruction manual.

To select a programme for recording or timed display

1. With the EPG menu on screen, press the **▲**, **▼**, **◀** or **▶** buttons to highlight a programme in the EPG menu that you wish to record, then press the OK button. The Timer screen appears.



2. Press the RED button and your VCR will automatically record the selected programme when it starts (only if your VCR has Smartlink facility), or press the GREEN button if you wish the programme to appear on your TV screen when transmission begins.

Notes: If you do not have a Smartlink VCR, a message appears on screen to inform you. Press the RED button to store the programme settings on the TV, then set the timer recording function on your VCR to correspond with the programme you have stored for recording.

When a programme has been stored for recording, a solid bar appears in the EPG display directly under the timer bar. This solid bar shows you the amount of time allocated to a recording, and reminds you that you are unable to record any other programmes during that period of time.

To set the Manual Timer

1. With the EPG menu on screen, press the BLUE button to display the Timer List menu. If your VCR does not have Smartlink a message will be displayed reminding you to set your VCR timer. Press the RED button to display the 'Manual Timer Record' menu.



2. Press the **▲** or **▼** buttons to select the correct date. Press the **▶** button to highlight the start time.
3. Press the **▲** or **▼** buttons to select the start time. Press the **▶** button to highlight the stop time.
4. Press the **▲** or **▼** buttons to select the stop time. Press the **▶** button to highlight the programme.
5. Press the **▲** or **▼** buttons to select the programme. Press the OK button to store. The Timer List menu is displayed. The event is now set to the Timer List. Press the YELLOW button to delete the timed event or press the BLUE button to return to the main EPG screen.
6. Press the RED button and repeat steps 2 to 5 if you wish to store further programmes for recording.
7. Press the **⏏** button to return to normal TV operation.
8. Set the timer recording function on your VCR to switch on and off to correspond with the programmes you have stored for recording.

Note: Once a programme has started recording, do not switch channels or the recording will be cancelled.

To cancel a previously set event

1. With the EPG menu on screen, press the BLUE button to display the Timer List.
2. Press the **▲**, **▼**, **◀** or **▶** buttons to highlight the programme/event you wish to cancel.
3. Press the YELLOW button to cancel the programme/event.



Basic Operation

The Digital INFO display

This menu gives you information on the programmes currently being shown as well as those programmes which are on next.

1. With the TV in Digital mode, press the **i+** button on the remote control to display the 'Digital INFO display' screen.



2. Press the **▶** button to obtain a brief description of the next programme in the schedule. If the programme box is blank, there is no information currently available. To return to the starting point, press the **◀** button repeatedly until the description for the current programme reappears.
3. Press the **i+** button on the remote control at any time to exit the 'Digital INFO display'.

Note: To change channels while the 'Digital INFO display' is on screen, press the relevant numbered buttons on the remote control.

Using other INFO menu features

Subtitles

This feature will place Digital subtitles on the screen (similar to selecting p.888 in analogue Teletext mode).

With the 'Digital INFO display' on the TV screen, press the **RED** button to access the 'Subtitles' pop-up menu. Press the **▲** or **▼** button to highlight the language required then press **OK** to select.

To remove subtitles from the TV screen, access the 'Subtitles' pop-up menu and select 'Off'.

Audio

This feature allows you to listen to the broadcast in different languages*.

With the 'Digital INFO display' on the TV screen, press the **GREEN** button to access the 'Audio' pop-up menu. Press the **▲** or **▼** button to highlight the language required then press **OK** to select.

Note: *Only when the programme is broadcast in multiple languages.

REC/Timer

If you highlight a current programme, the **REC** feature allows you to automatically set your VCR to record the selected programme**.

With the 'Digital INFO display' on the TV screen, press the **YELLOW** button to access the 'REC' pop-up menu. If your VCR does not have Smartlink a message is displayed reminding you to manually set your VCR. Press the **RED** button to continue or press the **BLUE** button to return to the INFO display.

If you highlight a future programme, the **Timer** feature allows you to automatically set your VCR to record the selected programme, or have the TV switch to the correct channel automatically when the selected programme starts.

Press the **RED** button and your VCR will automatically record the selected programme when it starts (only if your VCR has Smartlink facility), or press the **GREEN** button if you wish the programme to appear on your TV screen when transmission begins.

Notes: **Only for Smartlink VCRs

Do not switch off the TV once a programme has been set to record. If you do not wish to view the programme being recorded, press the **TV I/O** button on the remote control to switch the TV into standby mode.

When a programme has been set to record and the TV is in standby mode the standby indicator on the front of the TV will flash green periodically to inform you that a programme has been set to record.

Do not change channels or switch the TV to analogue mode once a programme has started recording or the recording will be cancelled.

Set-up

With the 'Digital INFO display' on the TV screen, press the **BLUE** button to access the 'Main Menu'. The 'Main Menu' is explained on the following pages.



The Main Menu

The 'Main Menu' contains several features that will allow you to customise the Digital side of your TV. The 'Main Menu' is only available when watching Digital channels. If the TV is not already in Digital mode, press the DIGITAL/□ button on the remote control.

Favourite programme

This feature allows you to store your favourite channels in a list for quick access.

1. Press the **(i+)** button on the remote control to display the 'Digital INFO display'. Press the BLUE button to display the 'Main Menu'.
2. Press the **▲** or **▼** button to highlight 'Favourite Programme' then press the OK button to display the 'Favourite Programme Set' menu.



3. Press the **▲** or **▼** button to scroll through the list until the channel you wish to store as a favourite is highlighted. If you do not wish to select one of these channels as a favourite, press the RED or GREEN button to display the previous or next 5 channels in the list.
4. When you have found and highlighted a programme you want to register as a favourite, press the OK button. A tick appears alongside that programme in the display. If you wish to cancel your selection, press the OK button again.
5. Repeat steps 3 and 4 to store other programmes as favourites, then press the BLUE button to return to the main menu.
6. Press the YELLOW button on the remote control if you wish to delete (clear) all Favourite settings while in the 'Favourite programme' menu.
7. Press the BLUE button on the remote control to remove the 'Digital INFO display' from the TV screen.

Wallpaper

This feature allows you customise the background pattern of the Digital menus.

1. Press the **(i+)** button on the remote control to display the 'Digital INFO display'. Press the BLUE button to display the 'Main Menu'.
2. Press the **▲** or **▼** button to highlight 'Wallpaper' then press the OK button to display the 'Wallpaper' menu.



3. Press the **▲** or **▼** button to select your choice of wall paper followed by the OK button to store.
4. Press the BLUE button to return to the main menu.
5. Press the BLUE button on the remote control to remove the 'Digital INFO display' from the TV screen.

Advanced Operation

Parental Control

This feature allows you to set an age limit for programmes on the TV. If any films or programmes classed above the age limit you have set are broadcast, you will be requested to enter your PIN code before viewing is allowed.

In order to use the 'Parental Control' feature you must first set your PIN code.

If you have not already set a PIN code:

1. Press the **(i+)** button on the remote control to display the 'Digital INFO display'. Press the BLUE button to display the 'Main Menu'.
2. Press the **▲** or **▼** button to highlight 'Parental Control' then press the OK button to display the 'Parental Control' menu.



3. Press the RED button to display the PIN entry box on screen.
4. Using the numbered buttons on the remote control, enter a 4-digit number of your choice. As you enter each digit it will be represented by a * in the PIN entry box. Enter the code again to confirm.

Note: This will be your PIN number for the future - please use a number you can easily remember.

5. Press the OK button to confirm your PIN code.
6. Press the BLUE button to return to the 'Detail Set-up' menu.
7. Press the BLUE button to return to the 'Main menu'.

Follow Steps 2-5 of the instructions below:

If you have already set a PIN code:

1. Press the **(i+)** button on the remote control to display the 'Digital INFO display'. Press the BLUE button to display the 'Main Menu'.
2. Press the **▲** or **▼** button to highlight 'Parental Control' then press the OK button to display the 'Parental Control' menu.
3. Using the numbered buttons on the remote control, enter your 4-digit PIN code. As you enter each digit it will be represented by a * in the PIN entry box. Press the OK button to confirm your PIN code.
4. With the 'Age' box highlighted, press the **▲** or **▼** button to set the age limit you desire then press the OK button to confirm your setting.
5. Press the BLUE button to return to the 'Detail Set-up menu'.
6. Press the BLUE button to return to the 'Main menu'.
7. Press the BLUE button on the remote control to remove the 'Digital INFO display' from the TV screen.

Auto Tuning

This feature allows you to automatically re-tune all available Digital channels.

1. Press the **(i+)** button on the remote control to display the 'Digital INFO menu'. Press the BLUE button to display the 'Main Menu'.
2. Press the **▲** or **▼** button to highlight 'Auto Tuning' then press the OK button to display the 'Auto Tuning' menu.



3. Press the RED button to begin tuning in all available Digital channels.

Note: If you wish to cancel the 'Auto Tuning' process, press the BLUE button.





Detail Set-up

The 'Detail Set-up' menu allows you to further customise your TV with the following features:

Manual Tuning

This feature allows you to select a channel number from the displayed list and change the digital services of that channel.

1. Press the **i+** button on the remote control to display the 'Digital INFO display'. Press the BLUE button to display the 'Main Menu'.
2. Press the **▲** or **▼** button to highlight 'Detail Set-up' then press the OK button to display the 'Detail Set-up' menu.
3. Press the **▲** or **▼** button to highlight 'Manual Tuning' then press the OK button to display the 'Manual Tuning' menu.



4. Press the **▲** or **▼** button to highlight the chosen channel number for your new channel. If you do not wish to select any of the programme numbers listed, press the RED or GREEN button to display the previous or next 5 programme numbers on the list.
5. With your channel number highlighted, press the OK button to display the 'Manual Programme Search' screen.
6. Press the **▲** or **▼** button if you wish to change the channel number, then press the **▶** button to make the select search box active.
7. Press the **▲** or **▼** button to begin the search process. The words 'Searching Down' or 'Searching Up' appear in the select search box to indicate that the TV is searching. If no Digital services are found on the channel you have chosen, the channel number changes up or down automatically and the search continues. When all services allocated to the selected channel have been found, the service selection screen is displayed.
8. Press the **▲** or **▼** button to find and highlight the service you wish to allocate to the channel number selected in Step 4, then press the OK button to display the channel selection screen.
9. Repeat Steps 4 to 8 if you wish to manually add more channels to your TV.
10. Press the BLUE button on the remote control three times to remove the 'Digital INFO display' from the TV screen.

PIN Code

This feature allows you to set a 4-digit PIN code.

1. Press the **i+** button on the remote control to display the 'Digital INFO display'. Press the BLUE button to display the 'Main Menu'.
2. Press the **▲** or **▼** button to highlight 'Detail Set-up' then press the OK button to display the 'Detail Set-up' menu.
3. Press the **▲** or **▼** button to highlight 'PIN Code' then press the OK button to display the 'PIN Code' menu.



4. Enter your PIN code using the numbered buttons on the remote control. If you enter a wrong number, press the RED button to clear and start again.
5. Once you have entered a 4-digit code a cursor will appear in the second PIN Code box. Enter your new PIN code once again as confirmation. Press the OK button to confirm.
6. When both PIN codes match, a message appears to inform you that your new PIN code has been accepted. This is the PIN code you must use in future.
7. Press the BLUE button on the remote control to remove the 'Digital INFO display' from the TV screen.

Note: If you have forgotten your PIN code, please use 9999. This PIN code will always be accepted.

Advanced Operation

Software Download

Periodically Sony issues updates for the software that controls your TV. This feature allows you to automatically receive updates free through your existing aerial.

1. Press the **i+** button on the remote control to display the 'Digital INFO display'. Press the BLUE button to display the 'Main Menu'.
2. Press the **▲** or **▼** button to highlight 'Detail Set-up' then press the OK button to display the 'Detail Set-up' menu.
3. Press the **▲** or **▼** button to highlight 'Software Download' then press the OK button to display the 'Software Download' menu.



4. Press the **▲** or **▼** button to change the 'Current Setting'. If you wish to receive downloads, the 'Current Setting' should be set to 'On'. If you do not wish to receive downloads, the 'Current Setting' should be set to 'Off'.
5. Press the OK button to confirm.
6. Press the BLUE button to return to the Main menu.
7. Press the BLUE button on the remote control to remove the 'Digital INFO display' from the TV screen.

System Information

This is an information screen only. It tells you the current version of the software in your TV together with the signal strength, as indicated by the coloured bar in the display.

1. Press the **i+** button on the remote control to display the 'Digital INFO display'. Press the BLUE button to display the 'Main Menu'.
2. Press the **▲** or **▼** button to highlight 'Detail Set-up' then press the OK button to display the 'Detail Set-up' menu.
3. Press the **▲** or **▼** button to highlight 'System Information' then press the OK button to display the 'System Information' menu.



4. Press the BLUE button to return to the Main menu.
5. Press the BLUE button on the remote control to remove the 'Digital INFO display' from the TV screen.





CAM Set-up

This feature allows you to access a pay per view service once you have obtained a Conditional Access Module (CAM) and a viewing card. Please contact your nearest pay-per-view supplier for details.

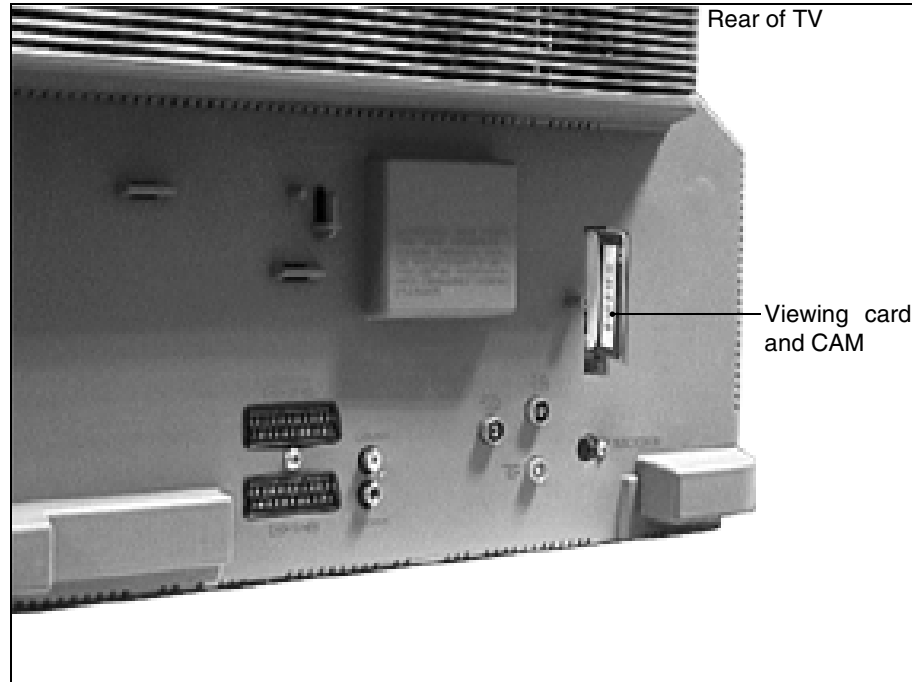
1. Switch off the TV and unplug from the mains.
2. Insert the CAM into the  socket on the rear of the TV as shown. Take care not to damage the CAM when inserting.

Always switch the TV **OFF** before inserting or removing the CAM.



3. Insert your viewing card into the CAM.
4. Connect the TV to the mains and switch on.
5. With the TV in Digital mode, press the  button on the remote control to display the 'Digital INFO display'. Press the BLUE button to display the 'Main Menu'.
6. Press the  or  button to highlight 'Detail Set-up' then press the OK button to display the 'Detail Set-up' menu.
7. Press the  or  button to highlight 'CAM Set-up', then press the OK button to display the CAM set up menu.

For further information regarding the CAM and services available, please contact your nearest pay-per-view supplier.

Advanced Operation

The TV menu system

This TV contains a menu system which is based on a series of user friendly on-screen displays. These displays will help you to get the most from your TV, helping you to change the picture settings, sound settings and change the order of the TV channels.

The Picture Adjustment menu

1. Press the MENU button to display the main menu, then press the \rightarrow button to enter the 'Picture Adjustment' menu.



2. 'Mode:' is highlighted. Press the \downarrow or \uparrow button to highlight one of the options, then after pressing the \rightarrow button to activate the option press \rightarrow and \leftarrow or \downarrow and \uparrow buttons to adjust the setting.
3. Press the OK button to store the new setting and repeat step 2 to adjust the other options. The Mode option has three settings for you to choose from:-

Personal: This setting allows you to adjust the Brightness, Colour, Contrast and Sharpness* levels to suit your personal preference.

Live: This is a fixed setting and is recommended for live broadcasts.

Movie: This is a fixed setting and is recommended for watching films.

4. Press the MENU button to return to normal TV operation.

Notes: Highlight Reset and press OK only if you wish to return the picture to the factory preset levels.
*Sharpness is adjustable in analogue mode only.

The Sound Adjustment menu

1. Press the MENU button to display the main menu, then press the \downarrow button to highlight the ♪ symbol. Now press the \rightarrow button to enter the 'Sound Adjustment' menu.



2. 'Mode:' is highlighted. Press the \downarrow or \uparrow button to highlight one of the options, then after pressing the \rightarrow button to activate the option press \rightarrow and \leftarrow or \downarrow and \uparrow buttons to adjust the setting.
3. Press the OK button to store the new setting and repeat step 2 to adjust the other options. The Mode option has four settings for you to choose from:-

Personal: This setting allows you to adjust all the available options in the 'Sound adjustment' menu to suit your personal preference.

Rock: This is a fixed setting and is recommended for rock soundtracks.

Pop: This is a fixed setting and is recommended for pop soundtracks.

Jazz: This is a fixed setting and is recommended for jazz soundtracks.

Note: 'Treble' and 'Bass' settings can only be altered when the 'Mode' option is set to Personal.

4. When 'Detail Adjustment' is highlighted, press the \rightarrow button to display the 'Detail Adjustment' sub menu. This menu gives you a further three options to choose from.

continued...

Advanced Operation

- Highlight and activate one of the options using the \blacktriangledown and \blacktriangleright buttons, then press the \blacktriangledown or \blacktriangle buttons to set the option to On or Off. See the table below for an explanation of each option and their effects.
- Press the OK button to store the new setting, then repeat step 5 to alter the other options.
- Press MENU button to return to normal TV operation.

Dolby* Virtual	When set to 'On', the TV simulates the effects of Dolby Pro Logic Surround sound. Note: If you connect headphones to this TV or if you set the 'Auto Volume' option to 'On', 'Dolby Virtual' will automatically be set to Off.
Auto Volume	When set to 'On', the volume level will remain constant even if the broadcast level should change, i.e. during commercial breaks. Note: This option automatically sets itself to 'Off' when 'Dolby Virtual' is set to 'On'.
TV Speakers	Set to 'Off' if you wish to connect an external amplifier to the audio output sockets on the rear of the TV.

• Notes on the Sound Adjustment menu

- Highlight 'Reset' and press OK only if you wish to return the sound settings to their factory preset levels.
- When receiving a bilingual broadcast set the 'Dual Sound' option to 'A' for channel 1 sound, 'B' for channel 2 sound or 'Mono' if the mono channel is available for selection. When receiving a stereo broadcast the 'Dual Sound' option can be set to Stereo or Mono.
- * This TV has been designed to create a Virtual Dolby Surround sound effect from a 'Dolby Pro Logic Surround' broadcast without the need for additional speakers. However, you can connect an external amplifier to this TV if desired (see 'Connecting additional equipment' section of this manual).
- * Manufactured under licence from Dolby Laboratories. 'Dolby', 'Pro Logic' and the double-D symbol are trademarks of Dolby Laboratories.

The Timer menu

The 'Sleep Timer' allows you to select a period of time after which the TV automatically switches itself into standby mode.

- Press the MENU button to display the main menu. Use the \blacktriangledown or \blacktriangle button to highlight the ⌚ symbol. Press the \blacktriangleright button twice to highlight 'Off' in the 'SleepTimer' menu.



- Press the \blacktriangledown or \blacktriangle buttons to set the amount of time before the TV switches itself into standby. This can be in 15 minute intervals up to a maximum of 4 hours.
- Press the OK button to store.
- Press the MENU button to return to normal TV operation. One minute before the TV switches into standby, the time remaining is counted down on screen.

Note: In analogue mode you can check the time remaining until standby by pressing the i+ button. The time remaining is displayed in the bottom left corner of the TV screen.

Advanced Operation

The Set Up menu

The 'Set Up' menu contains many features that enable you to customise your TV. The following pages explain all of the features contained in the 'Set Up' menu.

Auto Tuning

The TV automatically tuned in all the available channels when you first installed the TV. Follow these instructions if you wish to re-install your TV at an alternative location or search for new channels that have been subsequently launched by broadcasters.

1. With the TV in analogue mode, press the MENU button to display the main menu. Press the \blacktriangledown or \blacktriangleup button to highlight the  symbol, then press the \blacktriangleright button to enter the 'Set Up' menu.



2. Press the \blacktriangledown or \blacktriangleup buttons to highlight 'Auto Tuning' then press the \blacktriangleright button to confirm. The autotune prompt display appears on screen.



3. Press the OK button to select 'Yes' and begin the autotune procedure. Whilst tuning is taking place, the search and store display appears on screen. When all available signals have been captured and stored, the display is removed and the TV returns to normal operation.

Notes: You can cancel the tuning at any time by pressing the MENU button.

Programme Sorting

You can use this feature to change the order in which the analogue channels are stored on your TV.

1. With the TV in analogue mode, press the MENU button to display the main menu. Press the \blacktriangledown or \blacktriangleup button to highlight the  symbol, then press the \blacktriangleright button to enter the 'Set Up' menu.
2. Press the \blacktriangledown or \blacktriangleup buttons to highlight 'Programme Sorting' then press the \blacktriangleright button to display the Programme Sorting menu on screen.



3. Press the \blacktriangledown or \blacktriangleup button to highlight the channel you wish to move to a new position, then press the OK button.
4. Press the \blacktriangledown or \blacktriangleup button to highlight the new channel number for your channel, then press the OK button.
5. Repeat steps 3 and 4 to move other channels if required, then press the MENU button to return to normal TV operation.

Programme Labels

This feature allows you to name an analogue channel using up to 5 characters (letters or numbers).

1. With the TV in analogue mode, press the MENU button to display the main menu. Press the \blacktriangledown or \blacktriangle button to highlight the  symbol, then press the \blackrightarrow button to enter the 'Set Up' menu.
2. Press the \blacktriangledown or \blacktriangle buttons to highlight 'Programme Labels', then press the \blackrightarrow button to display the Programme Labels menu on screen.



3. Press the \blacktriangledown or \blacktriangle button to highlight the channel number that you wish to name, then press the \blackrightarrow button until the first dash of the 'Label' column is highlighted.
4. Press the \blacktriangledown or \blacktriangle buttons until the letter or character you desire appears in the display (select '-' to insert a blank space), then press the \blackrightarrow button to confirm.
5. Repeat step 4 to add other characters or letters until the name is complete, then press the OK button to store.
6. Press the MENU button to return to normal TV operation.

AV Preset

The AV Preset feature allows you to assign a name to any equipment you connect to the sockets of this TV.

1. Press the MENU button to display the main menu. Press the \blacktriangledown or \blacktriangle button to highlight the  symbol, then press the \blackrightarrow button to enter the 'Set Up' menu.
2. Press the \blacktriangledown or \blacktriangle buttons to highlight 'AV Preset' then press the \blackrightarrow button to display the AV Preset menu on screen.



3. Press the \blacktriangledown or \blacktriangle buttons to highlight the socket that is connected to the equipment you wish to name (AV1 and AV2 represent the rear scart sockets whilst AV3 represents the side panel sockets), then press the \blackrightarrow button to highlight the 'Label' column.
4. There are 6 predefined labels for you to use or you can create your own name.
 - a) To use one of the predefined labels, press the \blacktriangledown or \blacktriangle buttons to choose from CABLE, SAT, VIDEO, DVD, CAM or GAME then press the OK button to store.
 - b) To create your own name, select Edit, then press the \blackrightarrow button to highlight the first dash or character in the display. Press the \blacktriangledown or \blacktriangle buttons until the first letter or character you desire appears (select '-' to insert a blank space) then press the \blackrightarrow button to confirm. Select the remaining letters or characters in this way then press the OK button to store.
5. Press the MENU button to return to normal TV operation.

Advanced Operation

Manual tuning

This feature allows you to manually add analogue channels one by one to your TV.



1. With the TV in analogue mode, press the MENU button to display the main menu. Press the \downarrow or \uparrow button to highlight the \square symbol, then press the \rightarrow button to enter the 'Set Up' menu.
2. Press the \downarrow or \uparrow buttons to highlight 'Manual Programme Preset' then press the \rightarrow button to display the 'Manual Programme Preset' menu on screen.



3. 'Programme:' is highlighted. Press \rightarrow button to highlight the programme number, then press the \downarrow or \uparrow buttons until your new channel number for your channel appears on screen (if you are tuning in a VCR please select programme number '0').
4. Press the \leftarrow button, then press \downarrow button to highlight 'Channel'. Press \rightarrow button to highlight existing channel number, then using the numbered buttons, enter the channel number of the broadcast you want or your VCR's channel number. If you do not know the channel number, press \downarrow or \uparrow buttons until the broadcast appears. Press the OK button twice to store.
5. Repeat steps 3 and 4 to select and store other channels, then press the MENU button to return to normal TV operation.

Naming a channel

This feature allows you to name an analogue channel using up to 5 characters (letters or numbers).



1. With the TV in analogue mode, press the MENU button to display the main menu. Press the \downarrow or \uparrow button to highlight the \square symbol, then press the \rightarrow button to enter the 'Set Up' menu.
2. Press the \downarrow or \uparrow buttons to highlight 'Manual Programme Preset' then press the \rightarrow button to display the 'Manual Programme Preset menu' on screen.
3. 'Programme:' is highlighted. Press \rightarrow button to highlight the channel number, then press the \downarrow or \uparrow buttons until the channel number you wish to name appears.
4. Press the \leftarrow button, then press \downarrow button to highlight 'Label'. Press \rightarrow button to enter label column, then press the \downarrow or \uparrow buttons until the first letter or character you desire appears (select '-' to insert a blank space). Press \rightarrow button to confirm your choice. Select the remaining letters or characters this way, then press the OK button twice to store.



5. Repeat steps 3 and 4 to name other channels, then press MENU button to return to normal TV operation.

Fine tuning

Normally, fine tuning is performed automatically. However, you can adjust it manually if you feel a slight tuning adjustment will improve the picture quality.

1. Select the analogue channel you wish to fine tune.
2. Press the MENU button to display the main menu. Pressing the \downarrow or \uparrow button to highlight the  symbol, then press the \rightarrow button to enter the 'Set Up' menu.
3. Press the \downarrow or \uparrow buttons to highlight 'Manual Programme Preset' then press the \rightarrow button to display the 'Manual Programme Preset menu' on screen.
4. Press the \downarrow button to highlight AFT, then after pressing the \rightarrow button to confirm, press the \downarrow or \uparrow button to adjust the fine tuning. The tuning adjustment range is from -15 to +15.



5. Press the OK button twice to store, then press the MENU button to return to normal TV operation.

Skipping a channel

This feature allows you to skip unused analogue channel positions when selecting channels with the PROG +/- buttons. However, you can still select a skipped channel by using the numbered buttons on the remote control.

1. With the TV in analogue mode, press the MENU button to display the main menu. Press the \downarrow or \uparrow button to highlight the  symbol, then press the \rightarrow button to enter the 'Set Up' menu.
2. Press the \downarrow or \uparrow buttons to highlight 'Manual Programme Preset' then press the \rightarrow button to display the 'Manual Programme Preset menu' on screen.
3. 'Programme:' is highlighted. Press \rightarrow button to highlight the channel number, then press the \downarrow or \uparrow buttons until the channel number you wish to skip appears.
4. Press the \leftarrow button, then press \downarrow button to highlight 'Skip'. Press \rightarrow button to enter the skip column, then press the \downarrow or \uparrow button to set to 'Yes'. Press OK button twice to store.



5. Repeat steps 3 and 4 to skip other channels then press MENU to return to normal TV.

Note: To cancel this function, repeat procedure and change 'Yes' to 'No' in step 3.

Advanced Operation

Noise Reduction

Sometimes a weak signal can produce a snowy picture (called picture noise). The 'Noise Reduction' feature can help to reduce this effect.

1. Press the MENU button to display the main menu. Press the \downarrow or \uparrow button to highlight the  symbol, then press the \rightarrow button to enter the 'Set Up' menu.
2. Press the \downarrow or \uparrow buttons to highlight 'Detail Set Up' then press the \rightarrow button to display the 'Detail Set Up menu' on screen.
3. Press the \downarrow button to highlight 'Noise Reduction' then after pressing the \rightarrow button to confirm, press the \downarrow or \uparrow button to set to 'AUTO'.



4. Press the OK button to store, then press the MENU button to return to normal TV operation.

Note: To cancel this function, repeat procedure and change 'AUTO' to 'Off' in Step 3.



AV2 Output

This feature allows you to set which signal source is output from the AV2 scart socket (labelled ) on the rear of the TV. If you connect a VCR to this socket, you can record from external equipment connected to the other sockets of the TV.

Note: If your VCR supports Smartlink this procedure is not necessary.

1. Press the MENU button to display the main menu. Press the \downarrow or \uparrow button to highlight the  symbol, then press the \rightarrow button to enter the 'Set Up' menu.
2. Press the \downarrow or \uparrow buttons to highlight 'Detail Set Up' then press the \rightarrow button to display the 'Detail Set Up menu' on screen.
3. Press the \downarrow button to highlight 'AV2 Output' then after pressing \rightarrow button to confirm, press the \downarrow or \uparrow button to choose which type of signal you want to output from the AV2 socket (see table below).



TV	Outputs the TV broadcast you are watching.
AUTO	The output signal will be whatever is being viewed on the TV.
YC3	Outputs signals from equipment connected to the  socket on the concealed side panel.
AV3	Outputs signals from equipment connected to the  socket on the concealed side panel.
AV1	Outputs signals from equipment connected to the  socket on the rear of the TV.

Note: If you connect a decoder to the AV2 scart or to a VCR connected to the AV2 scart, please set the 'AV2 Output' to 'TV' or 'AUTO' to enable correct unscrambling.

4. Press the OK button to choice of signal.
5. Press the MENU button to return to normal TV operation.

RGB Centring

The 'RGB Centring' feature allows you to adjust the horizontal picture position of RGB equipment connected to the AV1 scart socket (e.g. PlayStation).

1. Press the MENU button to display the main menu. Press the \downarrow or \uparrow button to highlight the  symbol, then press the \rightarrow button to enter the 'Set Up' menu.
2. Press the \downarrow or \uparrow buttons to highlight 'Detail Set Up' then press the \rightarrow button to display the 'Detail Set Up menu' on screen.
3. Press the \downarrow button to highlight 'RGB Centring' then after pressing \rightarrow button to confirm, press the \downarrow or \uparrow button until the centre of the picture is at the centre of the TV screen. The adjustment scale ranges from -10 to +10.



4. Press OK button to store, then press the MENU button to return to normal TV operation.

Note: If there is no equipment attached to the AV1 scart socket on the rear of the TV, the 'RGB Centring' option will not be available in the menu system.

Picture Rotation

Due to the Earth's natural magnetism the picture might slant slightly. The 'Picture Rotation' feature allows you to cancel out any such effect.

1. Press the MENU button to display the main menu. Press the \downarrow or \uparrow button to highlight the  symbol, then press the \rightarrow button to enter the 'Set Up' menu.
2. Press the \downarrow or \uparrow buttons to highlight 'Detail Set Up' then press the \rightarrow button to display the 'Detail Set Up menu' on screen.
3. Press the \downarrow button to highlight 'Picture Rotation' then after pressing \rightarrow button to confirm, press the \downarrow or \uparrow button to correct any picture slant. The adjustment scale ranges from -5 to +5.



4. Press the OK button to store, then press MENU button to return to normal TV operation.

Additional Information

Connecting additional equipment

You can connect a wide range of audio and video equipment to the rear of the TV as shown in the following illustration.

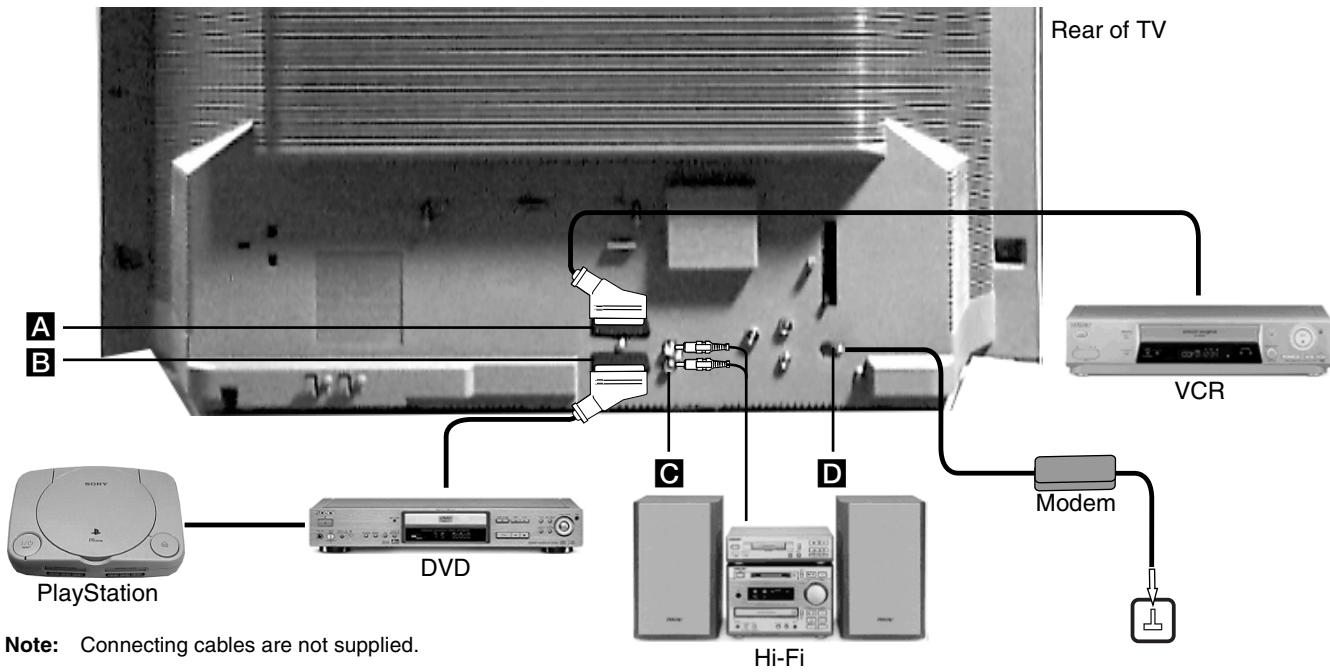

Note: Connecting cables are not supplied.

1. Connect your equipment as shown in the above illustration.
2. Press the button on the remote control until the correct symbol for your equipment appears on the TV screen (see table below).



On Screen Symbol	Input Signals
1	For Audio/Video equipment connected to socket B .
1	For RGB equipment connected to socket B . (Note: the on screen symbol will only appear if equipment is connected to the socket)
2	For Audio/Video equipment connected to socket A .
2	For S-VHS equipment connected to socket A .

Note: To record and playback digital programmes you must connect your VCR to the **A** socket using a scart lead.

3. Switch on the connected equipment. The picture from this equipment (if any) will appear on the TV screen.
4. Press the DIGITAL/□ button to return to normal TV operation.

Connecting a Smartlink VCR

Smartlink is a direct link between the TV and VCR. For more information on Smartlink, please refer your VCR instruction manual. Ensure that your Smartlink VCR is connected to the **A** socket, using a fully-wired 21-pin Scart lead.

Connecting to external audio equipment

Connect your Hi-Fi system to the **C** sockets if you wish to amplify the sound from the TV. If you use this facility, you will need to enter the 'Detail Adjustment' menu and set the 'TV Speakers' option to 'Off'. You can still adjust the audio level using the volume buttons on the remote control. If you want to enjoy the 'Virtual Dolby' effect through your Hi-Fi, place the left and right speakers each side of the TV. For best results, try and leave a space of 50cm between the speakers and the TV. Enter the 'Detail Adjustment' menu and set the 'Dolby Virtual' option to 'On'.

Connecting a Modem

Connect your Modem to the **D** socket and your telephone socket.

Connecting additional equipment

The following instructions explain how to connect equipment such as camcorders to the side control panel of the TV. Press the side door flap to reveal the control panel.

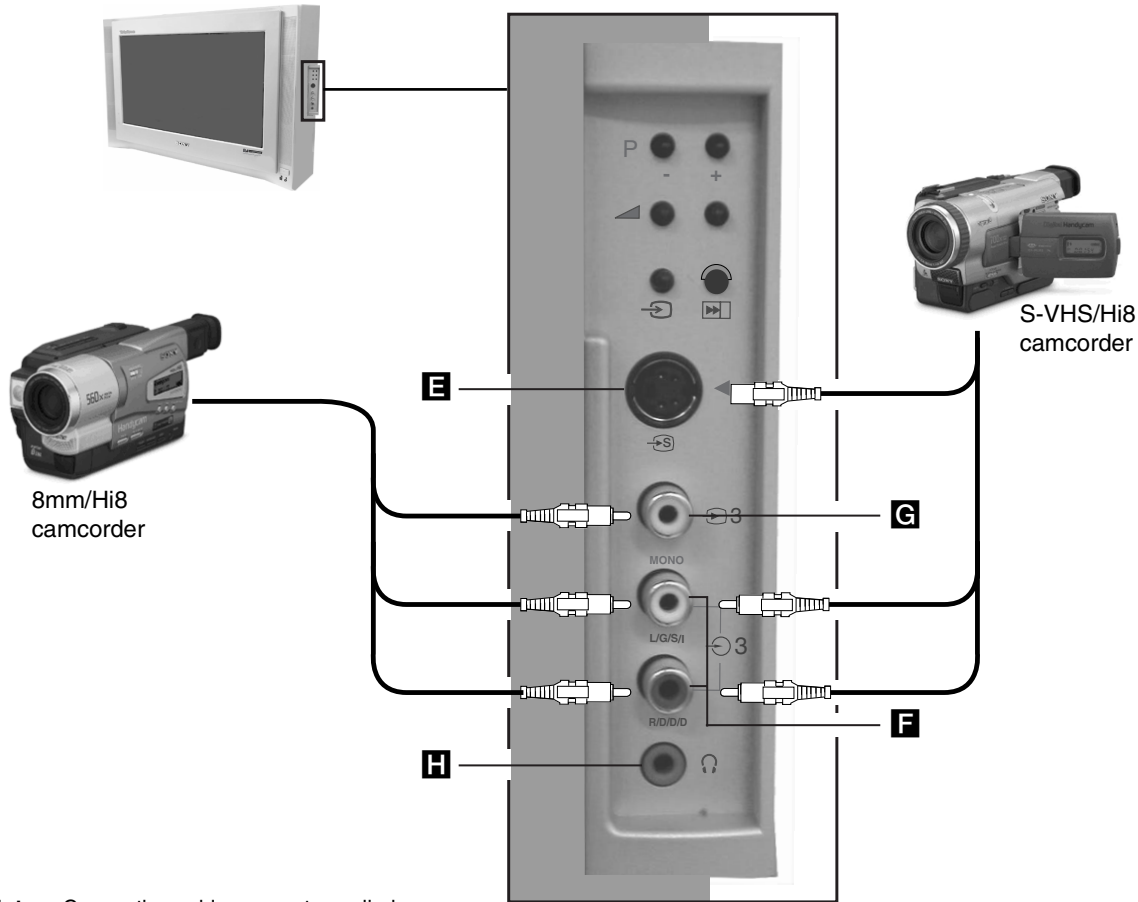

Notes: Connecting cables are not supplied.



1. Connect your equipment as shown in the above illustration.
2. Press the button on the remote control until the correct symbol for your equipment appears on the TV screen (see table below).

On screen symbol	Input signals
	For Audio/Video equipment connected to sockets F and G .
	For S-VHS equipment connected to sockets E and F .

3. Switch on the connected equipment. The picture from this equipment (if any) will appear on the TV screen.
4. Press the DIGITAL/ button to return to normal TV operation.

Note: To avoid picture distortion do not connect equipment to the **E** and **G** sockets at the same time.

Connecting headphones

Connect your headphones to **H** socket. The TV speakers are automatically muted when headphones are connected.

Additional Information

Remote control of connected equipment

This remote control can operate not only Sony DVDs and VCRs, but also those made by other manufacturers. The following instructions will guide you through the set up procedure.



1. Find the 3 digit code for your brand from the list below.
2. Press the Media Select button on the remote control until either the green VCR light is illuminated **OR** the green DVD light is illuminated.
3. Whilst the required green light is illuminated, press and hold down the YELLOW button for approximately 6 seconds, until the light starts to flash.
4. Use the numbered buttons to enter the 3 digit code for your DVD or VCR. Once a correct number has been entered, all three green lights will illuminate momentarily.
5. Turn on your DVD or VCR and check that the remote control operates the main functions. If not, repeat steps 2 - 4 and enter the next 3 digit code allocated to your brand of VCR or DVD.
6. When you wish to use the remote control to operate the TV again, press the Media Select button until the TV green light illuminates. Don't forget to select VCR or DVD using the Media Select button every time you wish to operate that equipment with this remote control.

Note: The brand codes you set may be lost if weak batteries are not replaced immediately. Should this happen, use the above procedure to re-enter the code. A small label has been attached to the inside of the battery cover for you to make a note of your brand codes. Not all brands and models of DVDs or VCRs are covered in this list, however, Sony will endeavour to update the software periodically. Please refer to the code table provided with your remote control.

VCR Brand List		DVD Brand List	
Brand	Code	Brand	Code
SONY (VHS)	301, 302, 303, 309	SONY	001
SONY (BETA)	303, 307, 310	AIWA	021
SONY (DVD)	304, 305, 306	DENON	018, 027, 020, 002
AIWA	325, 331, 351	GRUNDIG	009, 028, 023, 024, 016, 003
AKAI	326, 329, 330	HITACHI	025, 026, 015, 004
DAEWOO	342, 343	JVC	006, 017
GRUNDIG	358, 355, 360, 361, 320, 351	KENWOOD	008
HITACHI	327, 333, 334	LG	015, 014
JVC	314, 315, 322, 344, 352, 353, 354, 348, 349	LOEWE	009, 028, 023, 024, 016, 003
LG	332, 338	MATSUI	013, 016
LOEWE	358, 355, 360, 361, 320, 351	ONKYO	022
MATSUI	356, 357	PANASONIC	018, 027, 020, 002
ORION	328	PHILIPS	009, 028, 023, 024, 016, 003
PANASONIC	321, 323	PIONEER	004
PHILIPS	311, 312, 313, 316, 317, 318, 358, 359	SAMSUNG	11, 14
SAMSUNG	339, 340, 341, 345	SANYO	007
SANYO	335, 336	SHARP	019, 027
SHARP	324	THOMSON	012
THOMSON	319, 350	TOSHIBA	003
TOSHIBA	337	YAMAHA	018, 027, 020, 002

Specifications

TV System

I/DVB-T

Colour System

PAL

NTSC 3.58, 4.43 (only Video In)

MPEG-2 MP@ML

Channel Coverage

UHF:B21-B69

Picture Tube

KD-28DX40: FD Trinitron WIDE Approx. 71cm (28inches)

KD-32DX40: FD Trinitron WIDE Approx. 82cm (32 inches)

Sound Output

Left/Right: 2x14W (music power)
2x7W (RMS)

Power Consumption

KD-28DX40: 112W

KD-32DX40: 111W

Dimensions (w x h x d)

KD-28DX40: Approx. 796 x 518 x 522mm



KD-32DX40: Approx. 883 x 567 x 562mm



Weight

KD-28DX40: Approx. 47kg

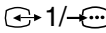
KD-32DX40: Approx. 65kg

Rear Terminals

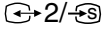
 1/  21-pin Euro connector (CENELEC standard) including audio/video input, RGB input, TV audio/video output.

 2/  3 21-pin Euro connector (CENELEC standard) including audio/video input, S-video input, selectable audio/video output.

 L/G/S1 R/D/D/D Audio outputs - phono jacks

MODEM Modem connection

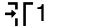
 1 RF In (Digital)

 2 RF In (Analogue)

 RF Out

 Conditional Access Module (CAM) socket

Concealed Side Terminals

 3 Video input - phono jack

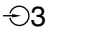
 3 Audio inputs - phono jacks

 S video input - 4 pin DIN

 Headphones jack - minijack stereo

Accessories Supplied

RM-933 remote control (1)

RF Loophrough Cable (1)











IEC designated size AA battery (2)

Design and specifications are subject to change without notice.

Additional Information

Troubleshooting

Here are some simple solutions to problems which may affect the picture and sound.

Problem	Cause
<p>No picture, no sound.</p> <p>Poor or no picture (screen is dark), but good sound. No Digital channels after tuning.</p> <p>Some channels are blank.</p> <p>Standby indicator flashing.</p> <p>Good Picture, no sound.</p> <p>Poor picture quality. No colour on colour programmes. Remote control does not function.</p> <p>Distorted picture when changing programmes or selecting Teletext.</p>	<ul style="list-style-type: none"> • Power off. • TV in standby. • Aerial disconnected. • Picture preset level adjustment. • No digital transmissions in your area. • No digital transmissions from the transmitter you are currently using. • Weak signal. • Unsuitable aerial. • Scrambled/subscription-only channel. • Programme used only for data (no picture or sound). • Programme not being transmitted. • Digital mode Timer Record active (regular flash). • Fault (irregular flash). • Volume control. • TV speakers turned off. • Headphones are connected. • Wrong external mode selected on an RGB video source. • Colour level setting. • Batteries low. Media Selector set to wrong mode for the equipment in use. • Inputs from external equipment not switched off.
Cause	Solution
<p>TV in standby.</p> <p>Aerial disconnected. Picture level adjustment.</p> <p>No Digital transmissions in your area.</p> <p>No Digital transmissions from the transmitter you are currently using. Unsuitable aerial.</p> <p>Weak signal.</p> <p>Scrambled/subscription-only channel. Programme information without picture or sound.</p> <p>Fault.</p> <p>Volume control. TV speakers turned off</p> <p>Wrong external mode selected.</p> <p>Colour level setting.</p>	<ul style="list-style-type: none"> • Plug in the TV. • Press the  button on the front of the TV. • If the  indicator is on press the  button or a numbered button on the remote control. • Check the aerial connection. • Select  on the TV menu system then adjust the brightness, picture and colour balance levels. • Contact a local installer to find out when digital transmissions begin in your area. • Contact a local installer to find out at which transmitter you should be pointing your aerial. • Change your aerial to cover the channels used by digital programmes. (Contact a local installer) • Ensure aerial is correctly aligned to transmitter. • Ensure aerial is plugged directly into the TV (not through other equipment). • Upgrade to a higher gain aerial. • Subscribe to pay-per-view broadcaster. • See 'Skipping a programme' section of this manual. • See 'Programme Sorting' section of this manual. • Do not open the cabinet, refer to qualified personnel. • Contact your nearest Sony Service Centre. • Press the  + button on the remote control. • Refer to 'The Sound menu' section in this manual • If  is displayed on the screen, press the  button on the remote control. • Disconnect headphones. • Press the  button repeatedly until the RGB symbol  is displayed on screen. • Select  on the TV menu system then adjust the colour setting.

- **If you continue to have these problems, have your TV serviced by qualified personnel or you can contact the Sony UK Digital HelpLine on 0870 600 1717.**
- **NEVER open the casing yourself.**

Index

4:3 mode **11**
14:9 mode **11**

A

Aerial, connecting **5**
Accessories, supplied **4**
Analogue mode, selecting **9**
Audio **16**
Audio Adjustment menu **24**
Auto Format **11**
Auto tuning (analogue) **6, 24**
Auto tuning (Digital) **18**
Auto volume **23**
AV2 Output **28**
AV Preset **25**

B

Batteries,
 inserting into the remote control **4**
Brightness, adjusting **22**
Buttons,
 overview of the remote control **7**
 overview of the TV buttons **8**

C

CAM Set-up **21**
Camcorder, connecting **31**
Category pop-up list **10, 14**
Channel Index menu **9**
Channels, changing **9**
Colour, adjusting **22**
Configuring, the remote control **32**
Connecting,
 an aerial **5**
 a Camcorder **31**
 a DVD **30**
 a Hi-Fi **30**
 a PlayStation **30**
 a Smartlink VCR **30**
 a VCR **5, 30**
 audio equipment **30**
 headphones **31**
Contrast, adjusting **22**

D

Dedicated Digital Teletext channels **12**
Detail Set-up menu **19**
Digital EPG menu **14**
Digital INFO display **16**
Digital mode, selecting **9**
Digital Teletext **12**
Dolby Virtual **23**
DVD, connecting **30**

E, F

EPG menu **14**
Fasttext **13**
Favourite programme **10, 17**
Fine tuning **27**
Fuse, replacing **Inside Cover (Front)**

G, H, I, J, K

Headphones, connecting **31**
Hi-Fi, connecting **30**
INFO display **16**
Jazz mode **22**

L, M, N

Lifting instructions **Back cover**
Live mode **22**
Main Menu (Digital) **17**
Manual Programme Preset menu **26**
Manual timer **15**
Manual tuning,
 analogue **26**
 Digital **19**
Media Select button **7, 32**
Movie mode **22**
Moving the TV **1**
Naming a programme **26**
Noise Reduction **28**

O

On/Off button **5**
Overview,
 of remote control **7**
 of the TV set buttons **8**

P, Q

Parental control **18**
Personal mode,
 picture **22**
 sound **22**
Picture Adjustment menu **22**
Picture Rotation **29**
PIN Code **19**
Playstation, connecting **30**
Plug, wiring **Inside Cover (Front)**
Pop mode **22**
Programme Index table, **9**
Programme,
 labels **25**
 naming **26**
 Sorting **24**
 Skipping **27**

R

Record **16**
Recording, automatically **15**
Remote control,
 overview **7**
 controlling other equipment **32**
Resetting,
 picture settings **22**
 sound settings **23**
RGB Centring **29**
Rock mode **22**
Rotation, picture **29**

S

Safety Information **2**
Screen format,
 automatic **11**
 manual **11**
Selecting,
 analogue mode **9**
 Digital mode **9**
Set Up menu,
 analogue **24**
 Digital **17**
Sharpness, adjusting **22**
Skipping a programme **27**
Sleep timer **23**
Smart mode **11**
Software Download **20**
Sound Adjustment menu **22**
Specifications **33**
Stand **1**
Subtitles **16**
Supplied accessories **4**
Switching on the TV **5**
System Information **20**

T

Table of contents **3**
Teletext,
 analogue **13**
 Digital **12**
Timed display **15**
Timer,
 cancelling **15**
 setting manually **15**
Tuning,
 automatically **6**
 manually (analogue) **26**
 manually (Digital) **19**
Troubleshooting **34**
TV buttons,
 overview **8**
TV menu system **22**
TV speakers **23**

U, V, W, X, Y, Z

Video input button **7, 8**
Video, watching **6**
Volume,
 adjusting **7, 8**
Wall Paper **17**
Wide mode **11**
Widescreen, watching **11**
Zoom mode **11**

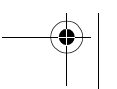
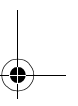
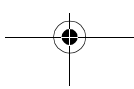
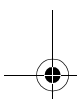
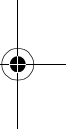
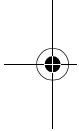
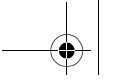

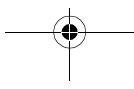
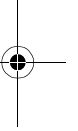
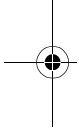
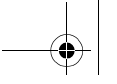

4-206-297-12



420629712

KD-28DX40U KD-32DX40U

Lifting Instructions

Sony strongly recommends that this TV should not be lifted by less than two people.

When lifting, always grip the TV as shown below.

Always assume the correct posture when lifting.

Take care not to trap your fingers when placing the TV on a flat surface or stand.

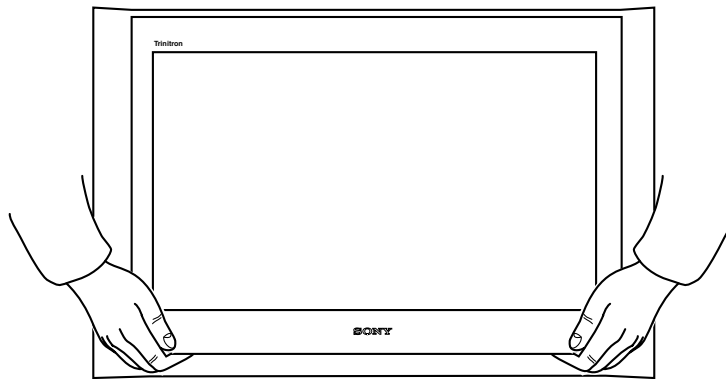
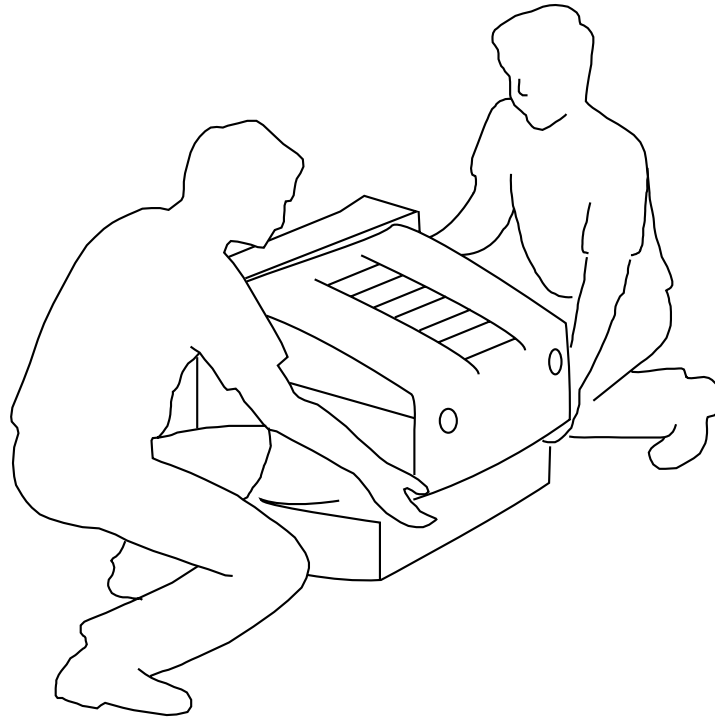

<http://www.world.sony.com/>

Sony Corporation Printed in UK



Recyclable